

# INSTALLATION MANUAL

67502B

**ecolight**



DARK  
LIGHT

80  
CRI

230V | SMD 2835 | 6W | IP65 | ABS + PC  
AC LED.

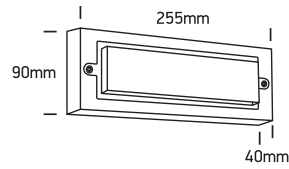

**one**  
LIGHT

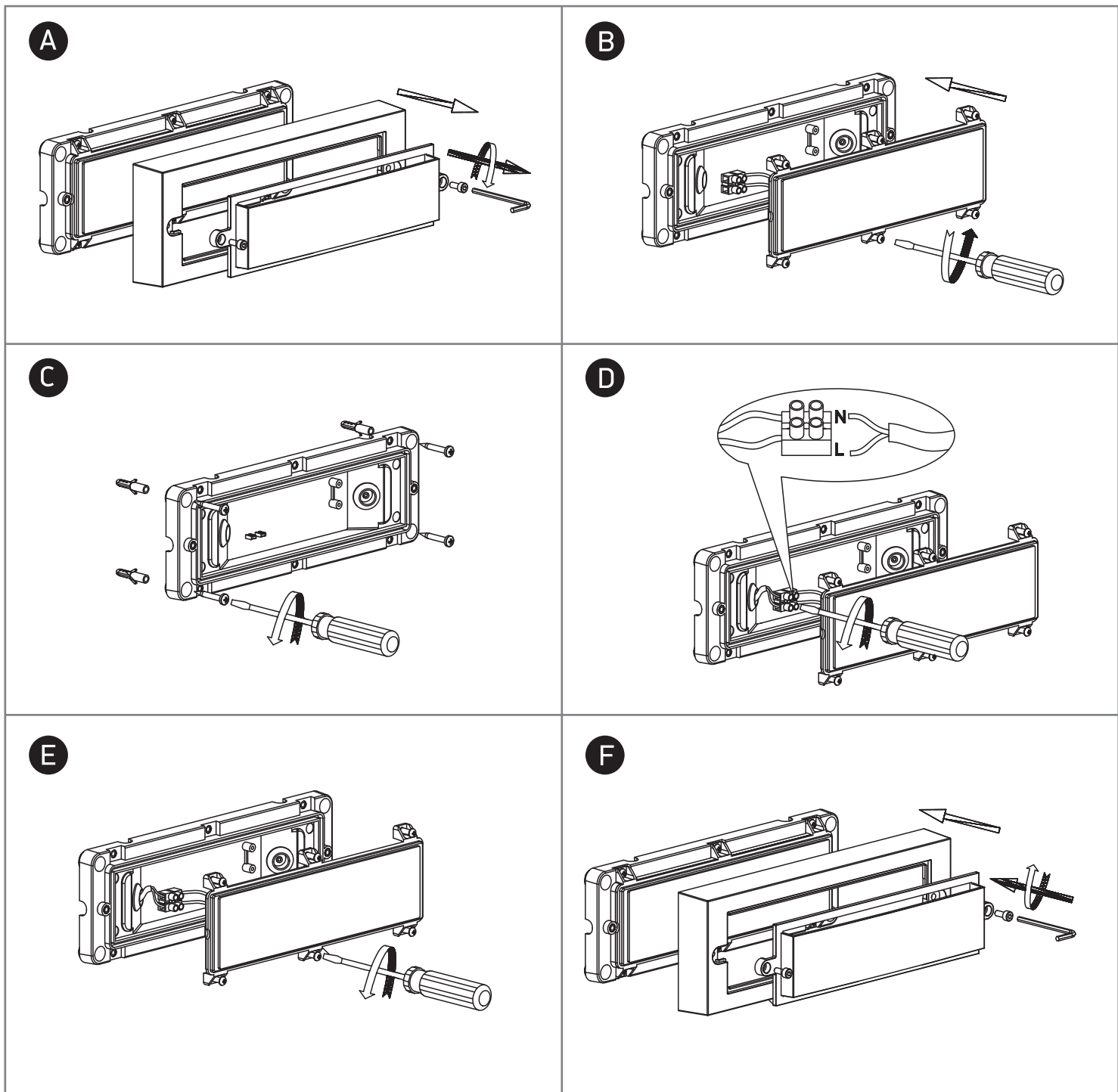

## Warnings:

1. Make sure that the product is installed properly before connecting to electricity.
2. Do not cover the fitting.
3. Maintenance and installation should only be carried out by a professional electrician.