

INSTALLATION MANUAL

65406BT

ecotrackspot

15W | 230V | 50/60Hz | IP20 | Die cast | Adjustable

Complete with 350mA driver

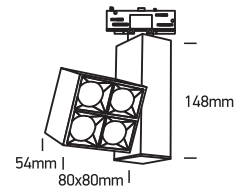
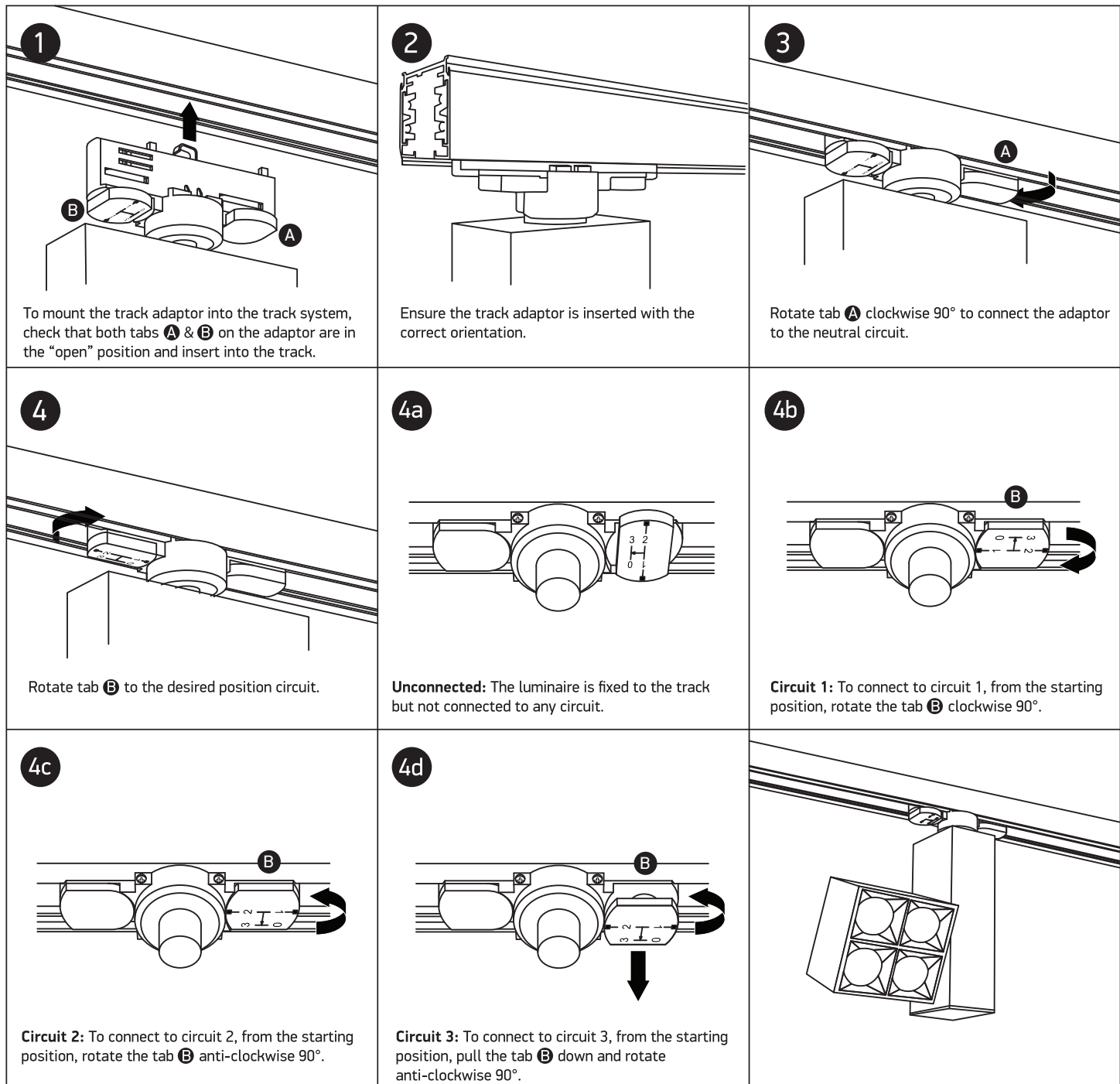
90
CRI

one
LIGHT

Warnings:

1. Make sure that the product is installed properly before connecting to electricity.
2. Do not cover the fitting.
3. Maintenance and installation should only be carried out by a professional electrician.