

INSTALLATION MANUAL

63100NA



230V | SMD 2835 | 100W | IP65 | UFO | Aluminium + PC

80
CRI

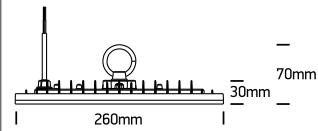

one
LIGHT

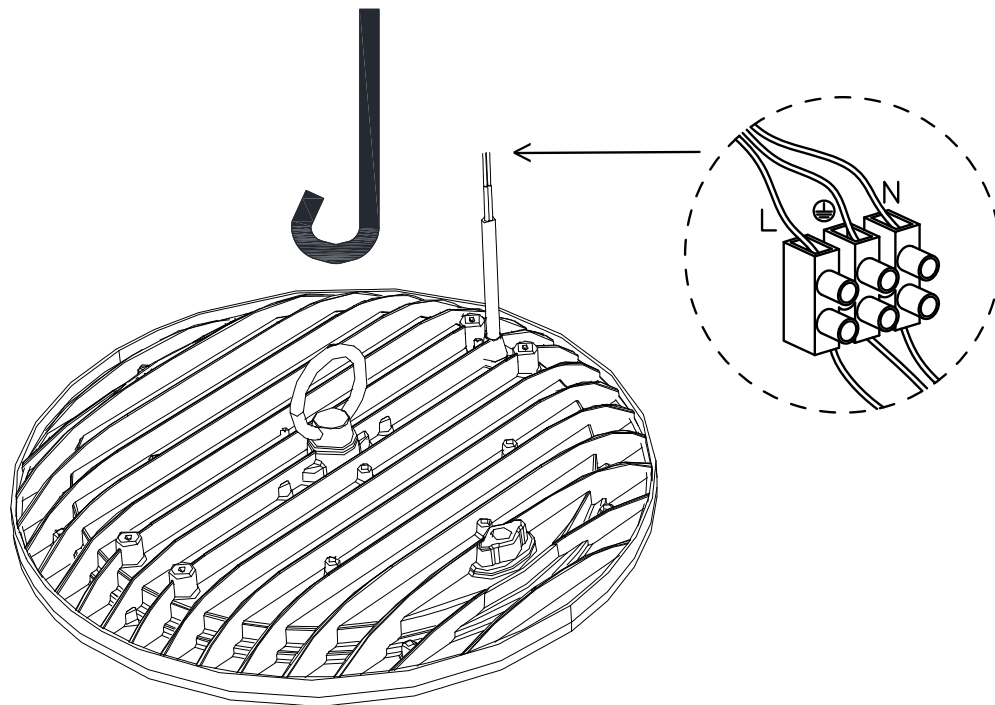

Warnings:

1. Make sure that the product is installed properly before connecting to electricity.
2. Connect the AC power cable, as shown in the above diagram.
3. Do not cover the fitting.
4. Maintenance and installation should only be carried out by a professional electrician.