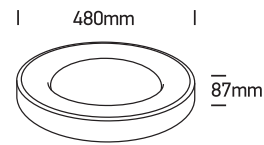
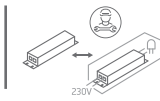
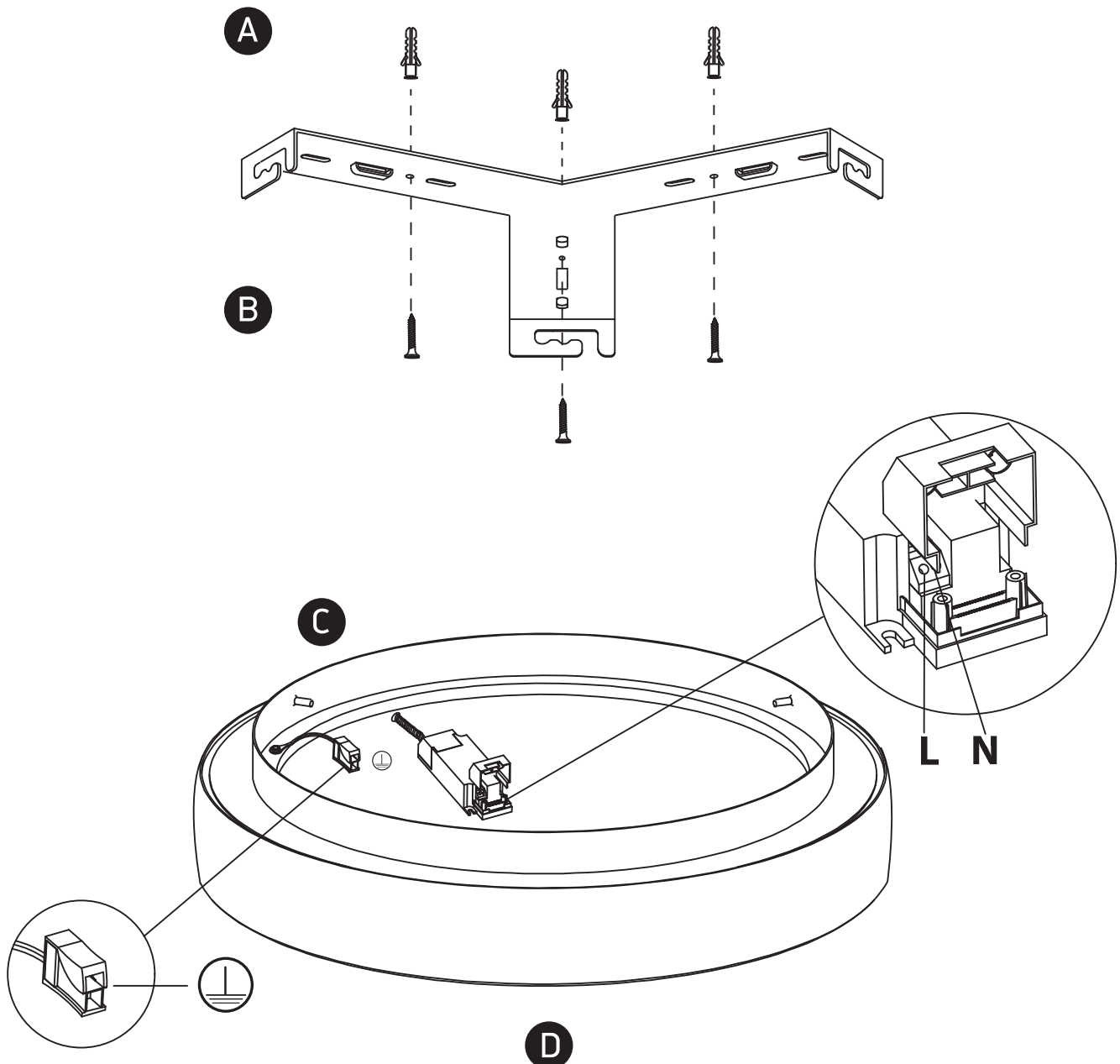

INSTALLATION MANUAL

62182

ecolight

230V | SMD 2835 | 40W | IP20 | Aluminium
Complete with 1050mA driver.

80 CRI
one
LIGHT

Warnings:

1. Fix the base on the ceiling.
2. Make sure that the product is installed properly before connecting to electricity.
3. Connect the AC power cable to the driver's cable as shown in the above diagram.
4. Do not cover the fitting.
5. Maintenance and installation should only be carried out by a professional electrician.