

INSTALLATION MANUAL

51206M

ecolight



90
CRI



350mA | COB LED | 2x6W | IP20 | Die cast | Adjustable
Requires 2x350mA drivers.

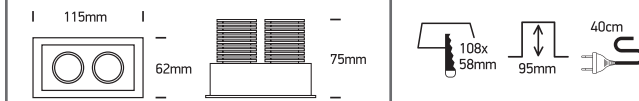

one
LIGHT



CUTOUT HOLE: 108x58mm

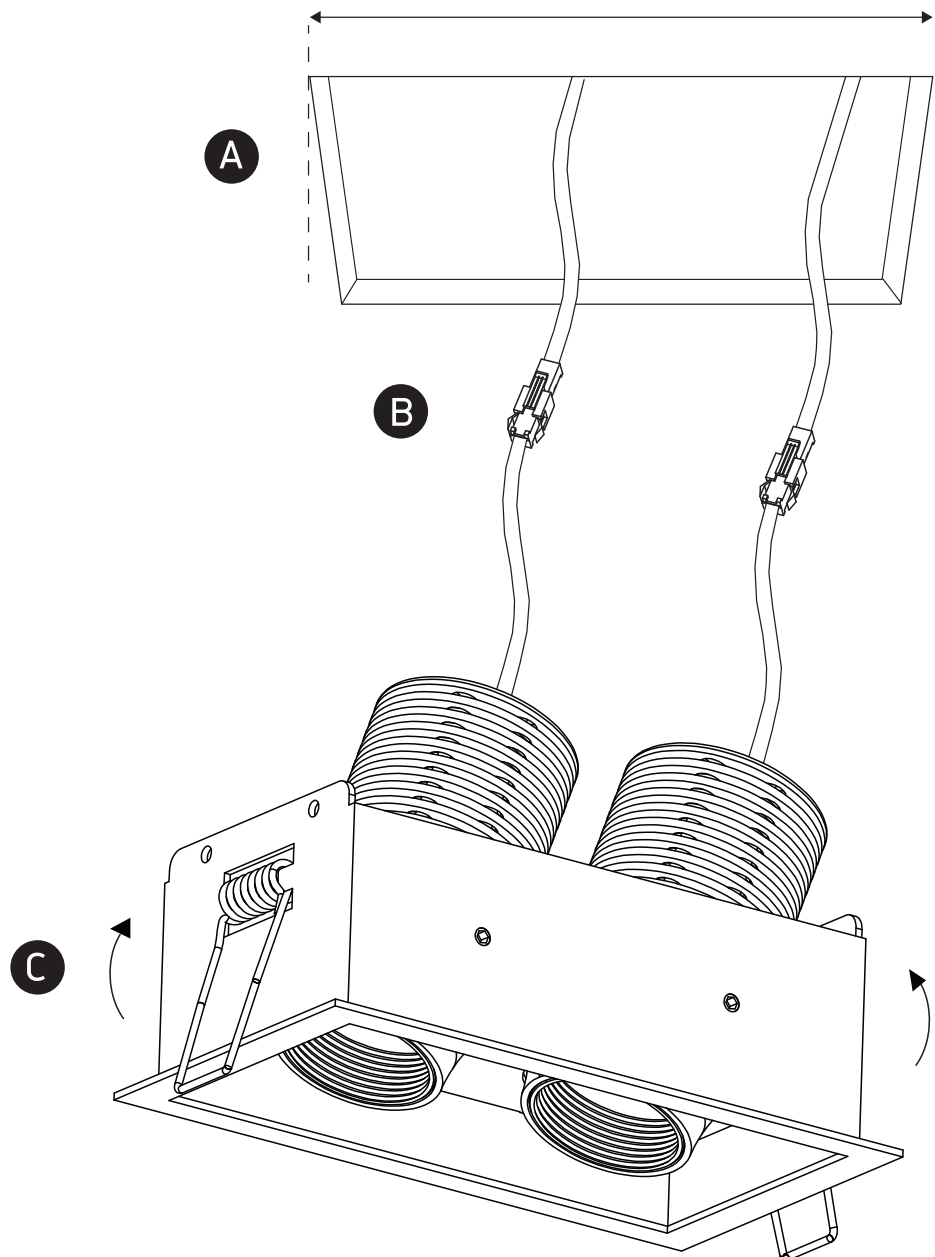

Warnings:

1. Make sure that the product is installed properly before connecting to electricity.
2. Do not cover the fitting.
3. Maintenance and installation should only be carried out by a professional electrician.