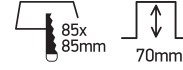
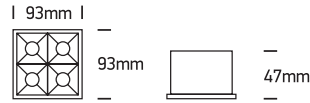
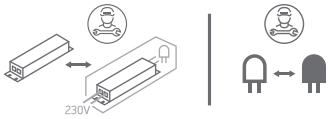
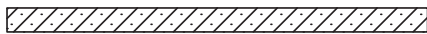
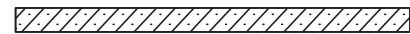
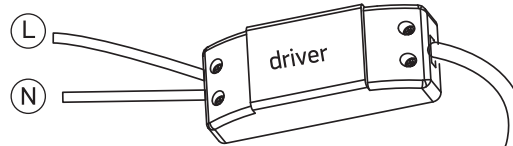
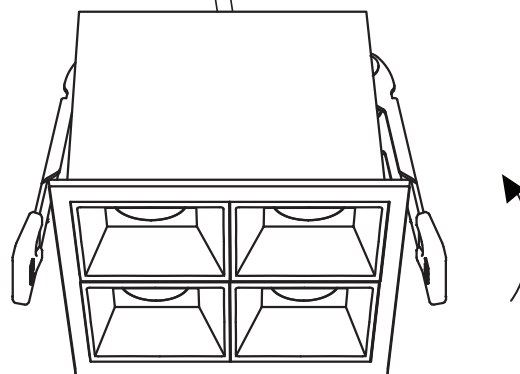

# INSTALLATION MANUAL

## 50406B

**ecolight**

**90  
CRI**

**230V | COB LED | 16W | IP20 | Die cast**
**Complete with 400mA driver.**

**one**  
L I G H T

**A**

**B**

**C**

### Warnings:

1. Make sure that the product is installed properly before connecting to electricity.
2. Do not cover the fitting.
3. Maintenance and installation should only be carried out by a professional electrician.