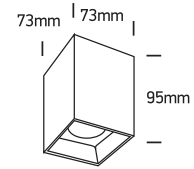

# INSTALLATION MANUAL

## 12112ZA

**ecolight**

 DARK  
LIGHT

230V | 12W | IP20 | Die cast + plastic reflector

Complete with driver.

 80  
CRI

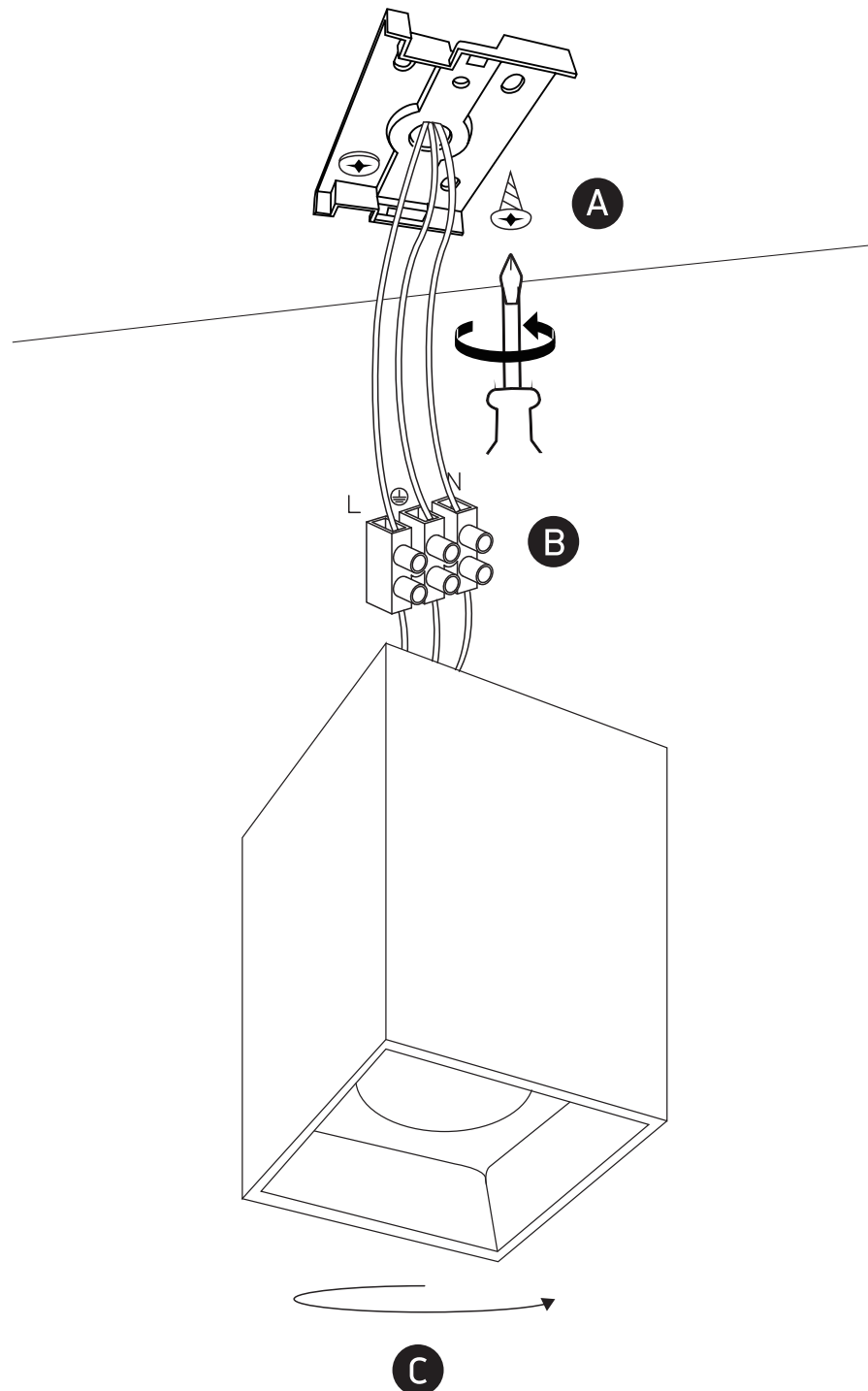
**one**  
LIGHT

### Warnings:

1. Make sure that the product is installed properly before connecting to electricity.
2. Do not cover the fitting.
3. Maintenance and installation should only be carried out by a professional electrician.