

INSTALLATION MANUAL

10120Z

ecolight

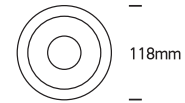

118mm

230V | 20W | IP20 | Die cast + plastic reflector
Complete with 500mA driver.

80
CRI

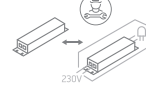
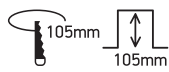

85mm

one
LIGHT

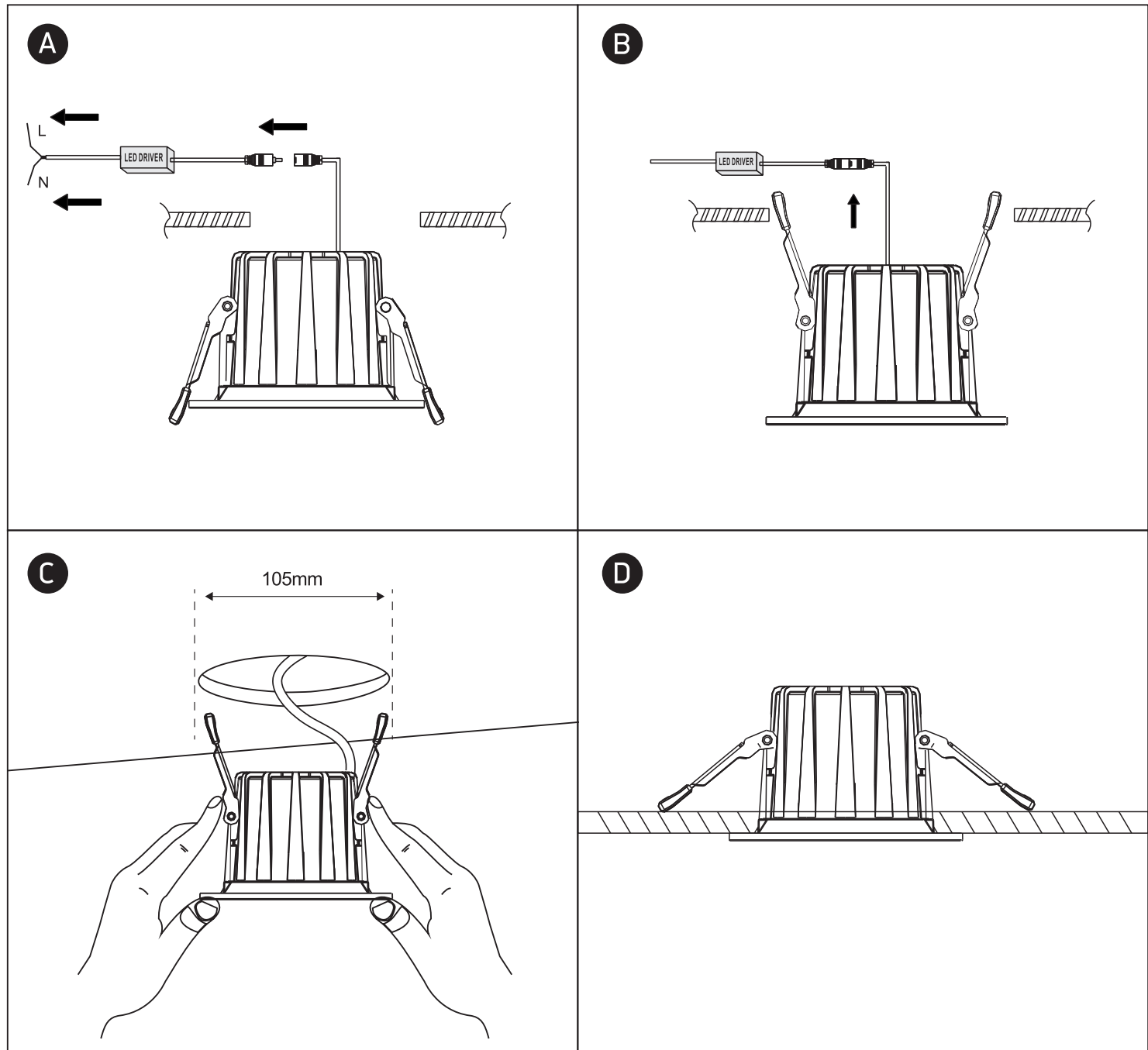

Warnings:

1. Make sure that the product is installed properly before connecting to electricity.
2. Do not cover the fitting.
3. Maintenance and installation should only be carried out by a professional electrician.