

# INSTALLATION MANUAL

## 10113UV

**LED**  
BUILT IN



UGR19

CE

EAC

UK  
CA

RoHS  
COMPLIANT

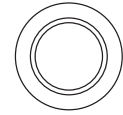

135mm

48mm

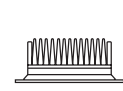

230V | SMD 2835 | 13W | IP44 | Adjustable CCT | Die cast

Complete with 300mA driver.

80  
CRI



**one**  
LIGHT

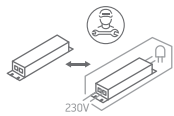

**B**

N

L

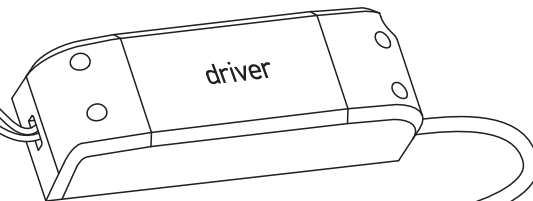

**A**

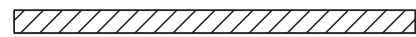
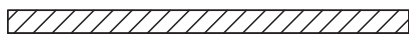

Adjustable CCT  
6000K-4000K-3000K

**C**

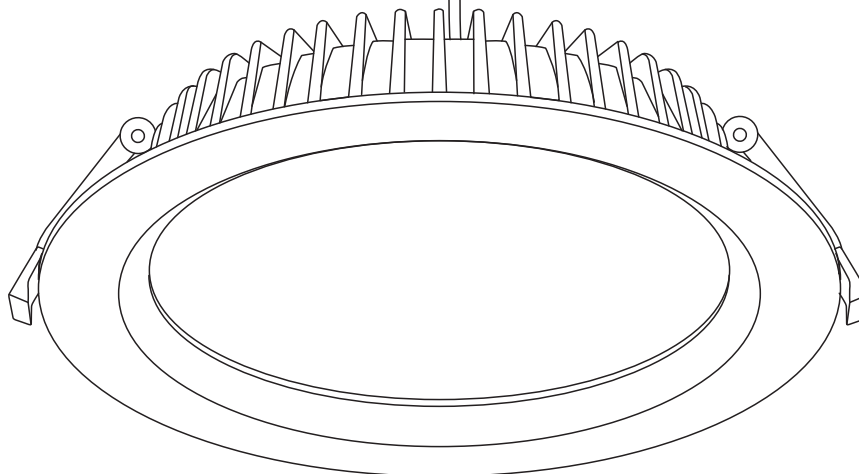

**D**



### Warnings:

1. Make sure that the product is installed properly before connecting to electricity.
2. Do not cover the fitting.
3. Maintenance and installation should only be carried out by a professional electrician.