

# INSTALLATION MANUAL

## 10112Z

**ecolight**

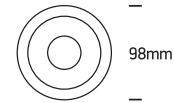

98mm

230V | 12W | IP20 | Die cast + plastic reflector  
Complete with 300mA driver.

80  
CRI

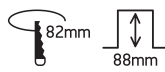

68mm

**one**  
LIGHT

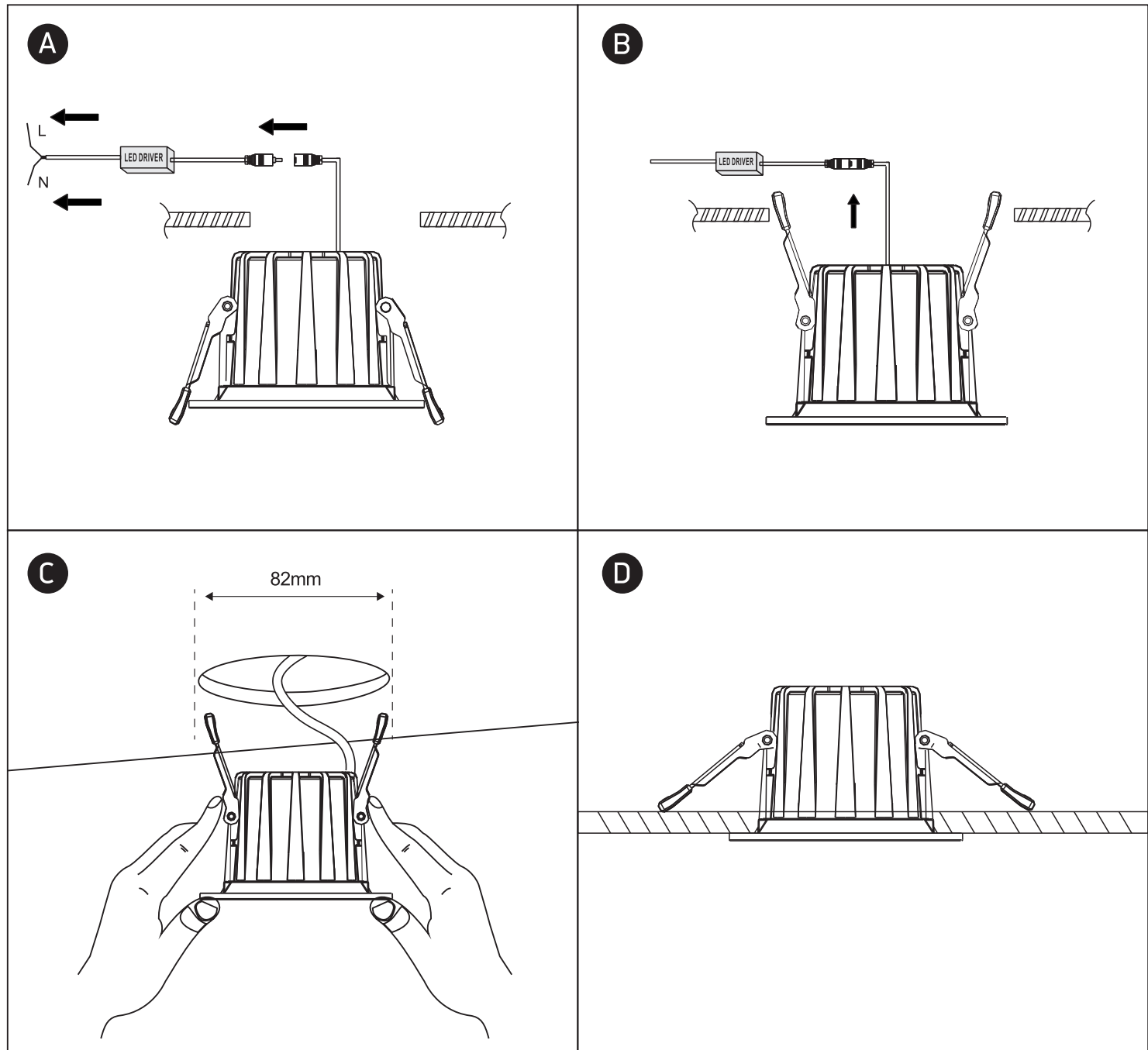

### Warnings:

1. Make sure that the product is installed properly before connecting to electricity.
2. Do not cover the fitting.
3. Maintenance and installation should only be carried out by a professional electrician.