

# CL KOS LED 10W

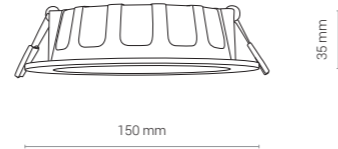

cut out  $\phi$  125 mm

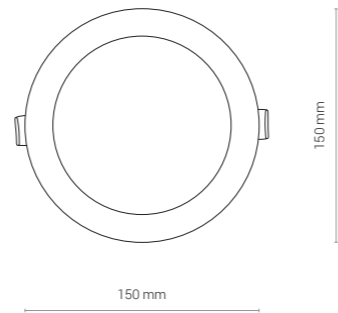
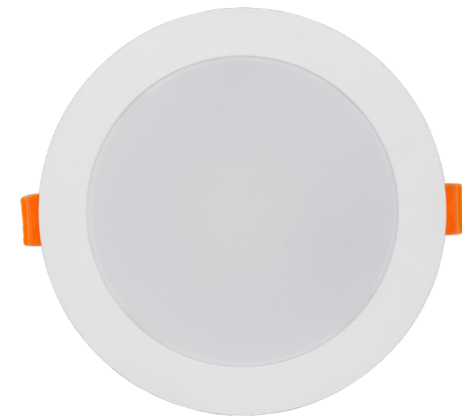

LUMINOUS INTENSITY DISTRIBUTION DIAGRAM

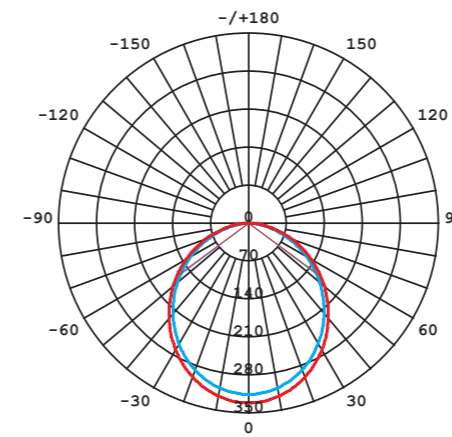

Luminous intensity [cd]  
C0-C180 —  
C90-C270 —

Beam cone diagram  
Beam angle 100°

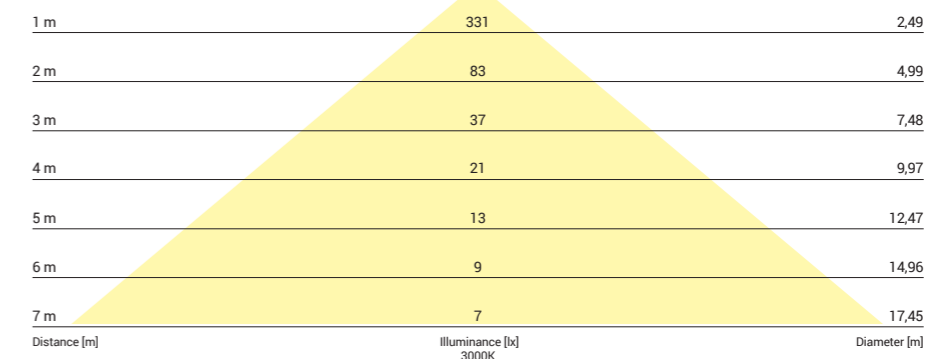

8780, 10W, 3000K, beam angle 100°

LUMINOUS INTENSITY DISTRIBUTION DIAGRAM

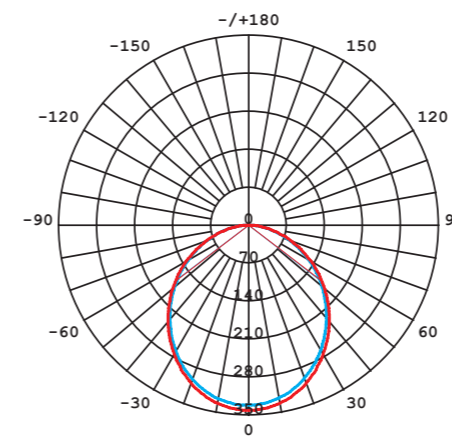

Luminous intensity [cd]  
C0-C180 —  
C90-C270 —

Beam cone diagram  
Beam angle 100°

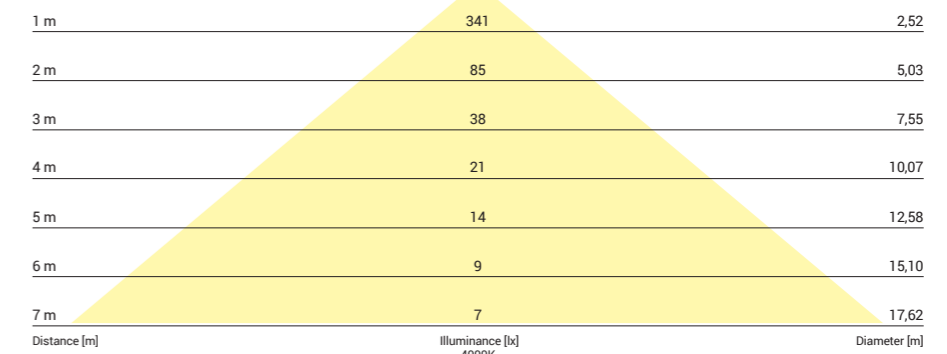

8778, 10W, 4000K, beam angle 100°

# CL KOS LED 10W

PC / PC / PC

8780 ○ WH - 3000K

8778 ○ WH - 4000K

Item No.	POWER	COLOUR TEMP.	LUMEN	BEAM ANGLE	CRI	IP	LED BRAND	DRIVER BRAND	LIFETIME	WARRANTY
8780	10W	3000K	850	100°	≥80	44	SANAN	DRIVER ON BOARD	50000h	5 YEARS
8778	10W	4000K	850	100°	≥80	44	SANAN	DRIVER ON BOARD	50000h	5 YEARS