

x 4

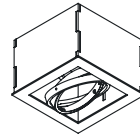

x 1-2

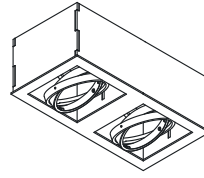

# BOX ANTIQUE

7650 | 7648

1

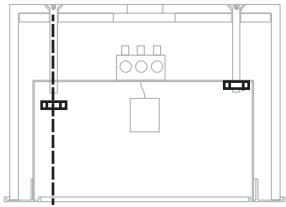

x 4

2

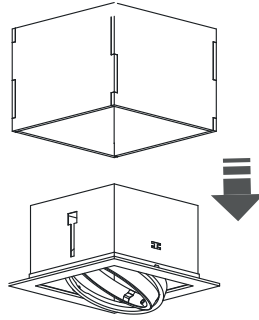

3

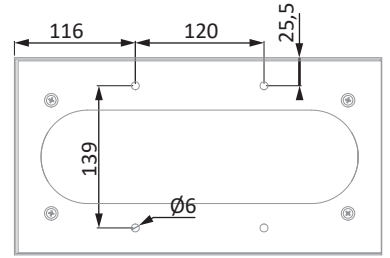
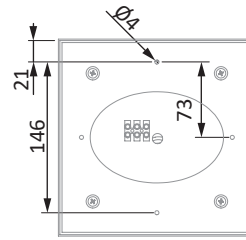

4

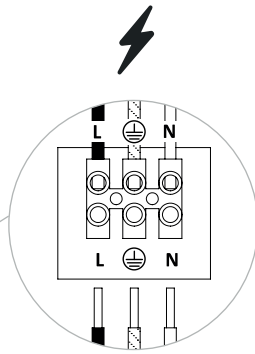
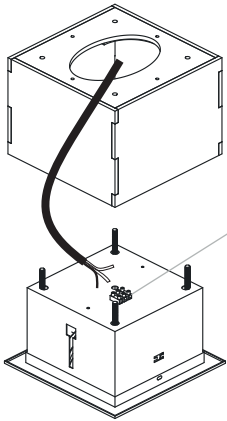

5

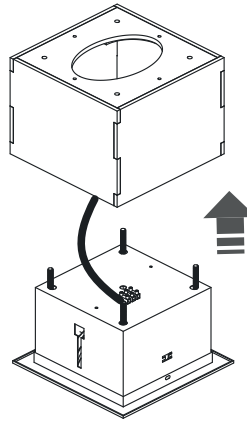

6

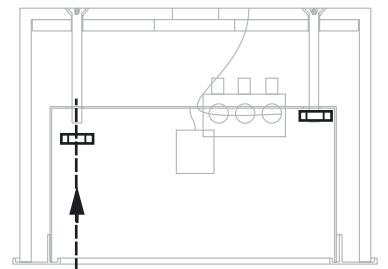

x 4

7

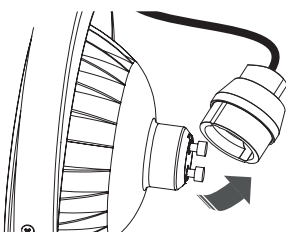
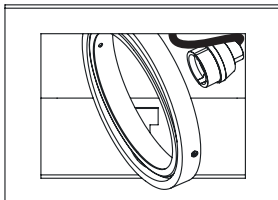

8

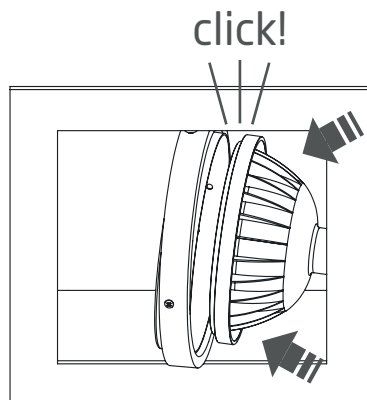

9

