

E 27 CLASS II 

Art.:259

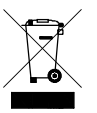

INSTR. N° 259
IX-2011

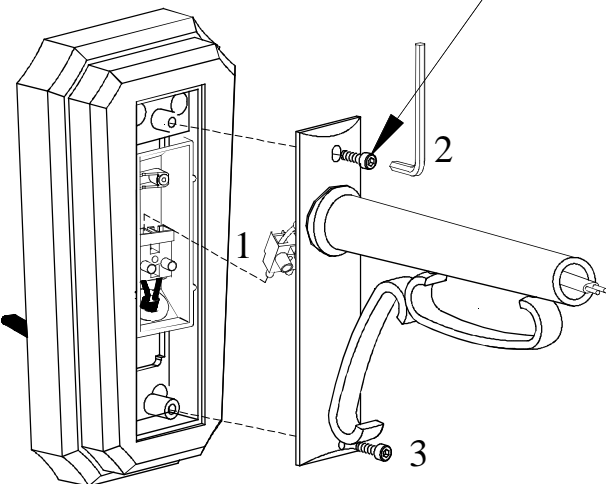
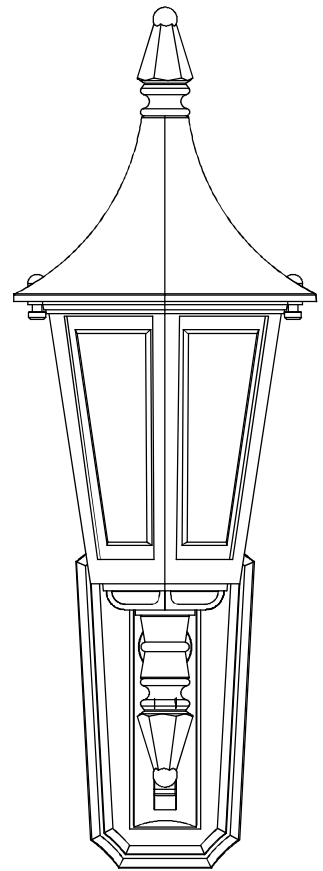
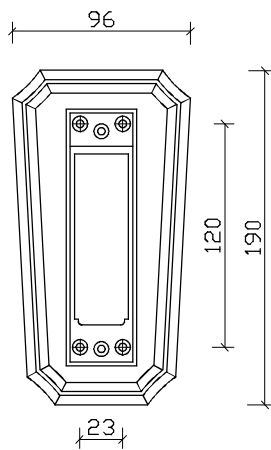
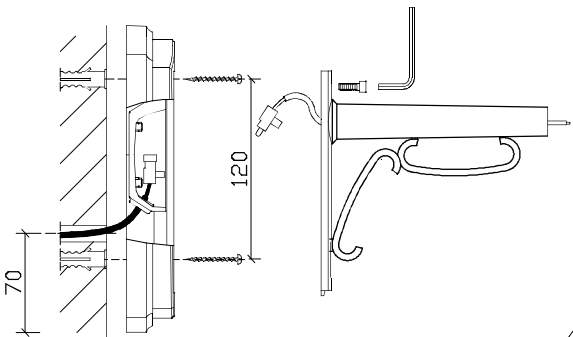
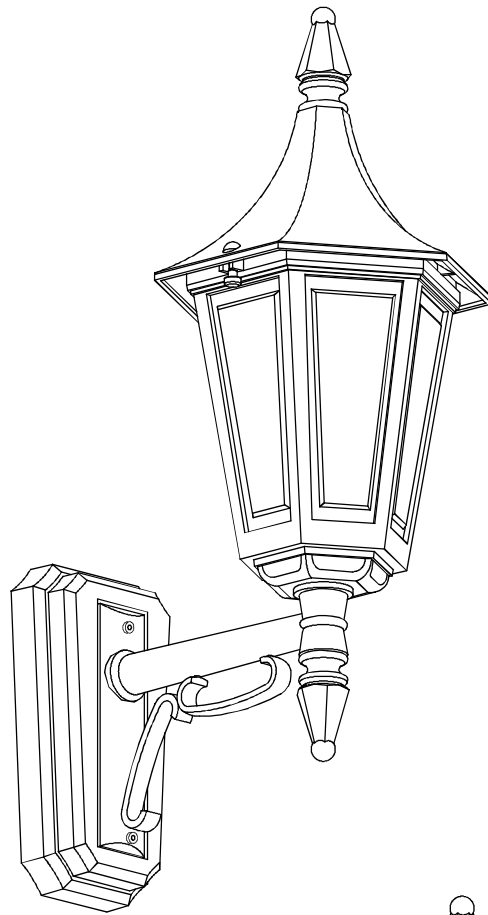
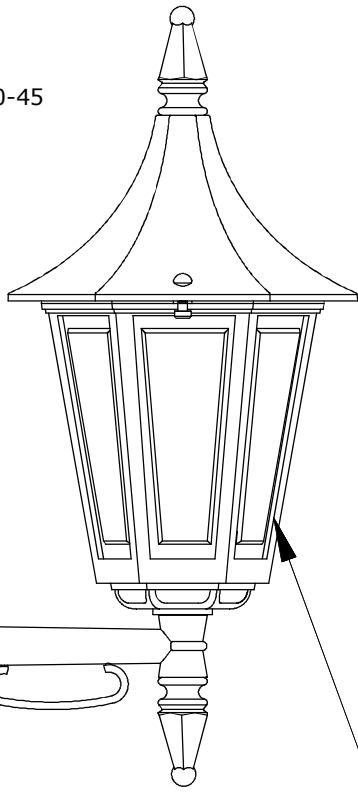