

E 27 CLASS II 

Art.:250

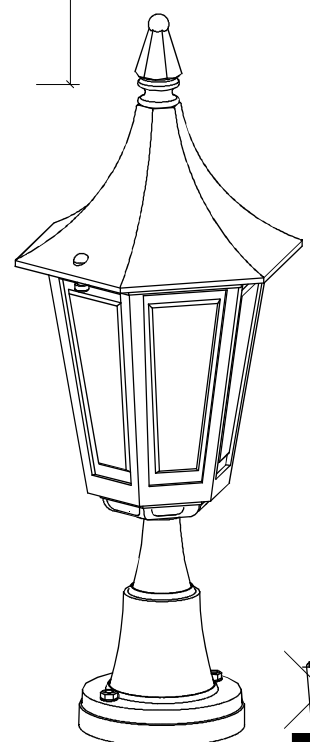

INSTR. N° 250
IX-2011

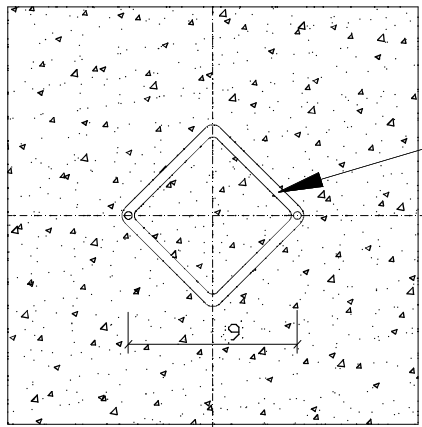
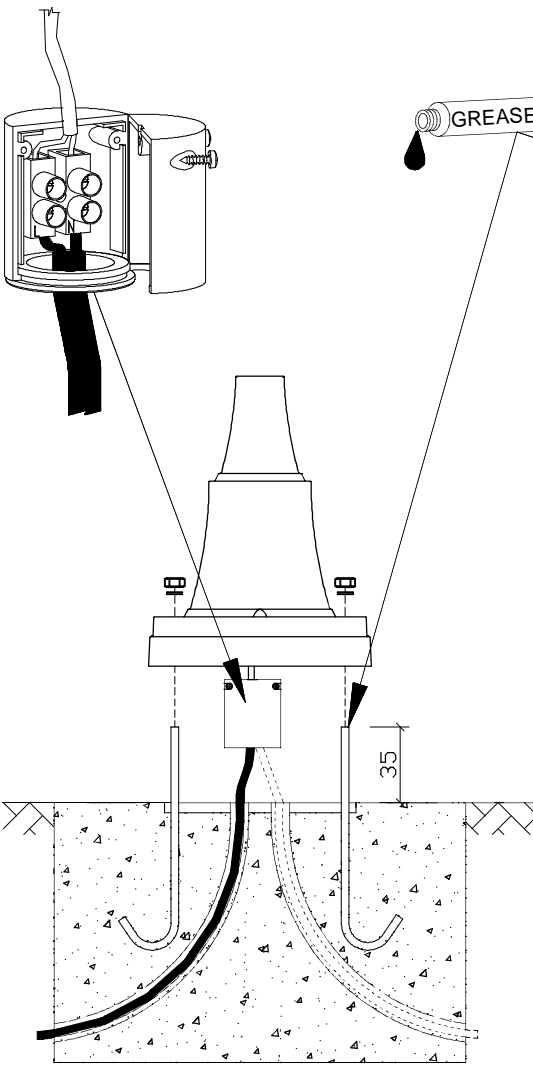
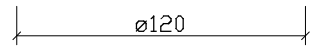
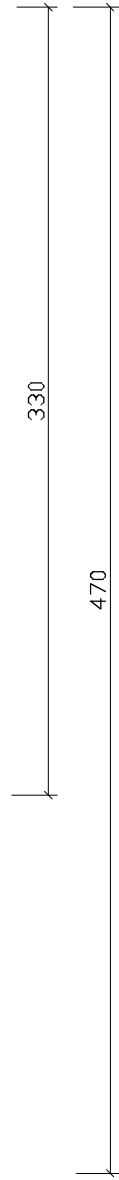
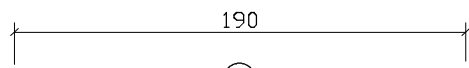
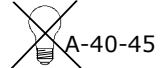
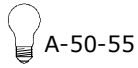