

## Fly

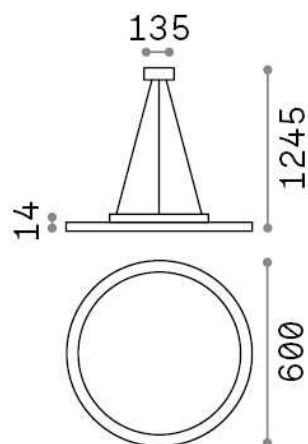

## General info

## Indoor - Suspensions

<b>Ean</b>	8021696308012
<b>Item</b>	FLY SLIM SP D60 4000K
<b>Installation</b>	Suspensions
<b>Guarantee</b>	5 years
<b>Gross weight</b>	8.8 kg
<b>Volume</b>	-

## Technical info

<b>Net weight</b>	7.3 kg
<b>Insulation class</b>	I
<b>Protection index</b>	IP40
<b>Compliance</b>	CE
<b>Operating temperature</b>	0° ~ +40 °C
<b>Dimmer</b>	Non-dimmable, On-Off
<b>Power output</b>	220-240 V AC 50/60 Hz
<b>Power supply</b>	In-built, included Replaceable (by qualified operators only), electronic, tridonic
<b>Accessories not included</b>	Dimmable driver, upright module

## Source info

<b>Integrated source</b>	Integrated LED module
<b>Replaceable source</b>	Replaceable (by qualified operators only)
<b>Power</b>	53 W
<b>Emission</b>	Direct
<b>Max consumption</b>	max 53,00 W
<b>Features LED</b>	LED SMD SAMSUNG
<b>CCT</b>	4000 K
<b>Duration LED (t. 25°C)</b>	50000 h
<b>CRI</b>	> 80
<b>SDCM</b>	3
<b>Light beam</b>	87°
<b>UGR Maximum</b>	< 19
<b>Light beam flux</b>	8000 lm
<b>Useful light flux</b>	6390 lm
<b>Photobiological risk</b>	1