

GAME ROUND

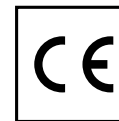
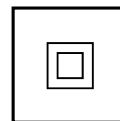
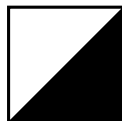
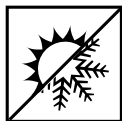
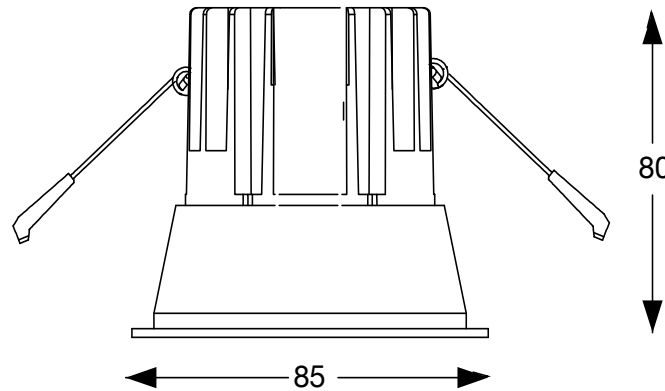

11W
11W
11W
11W
11W
11W
11W
11W
11W
11W
11W

3000 K
3000 K
3000 K
3000 K
3000 K
3000 K
3000 K
3000 K
3000 K
4000 K
4000 K

WH+BLACK
WH+GOLD
WH+SILVER
WH+WHITE
BK+BLACK
BK+GOLD
BK+SILVER
BK+WHITE
BK+BLACK
WH+WHITE

192277
192307
192284
192291
192314
192345
192321
192338
267968
267975

220 - 240 V AC

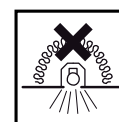
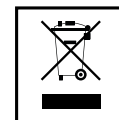

Fonte luminosa non sostituibile.
Not-replaceable light source.

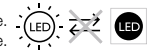

Driver sostituibile da un elettricista
qualificato.
Replaceable control gear by a
professional.

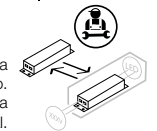

1

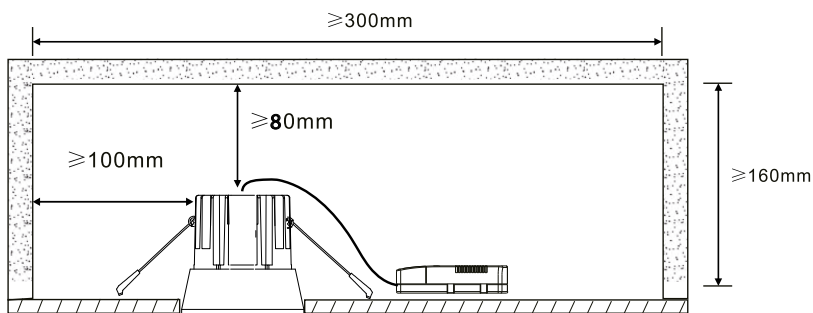
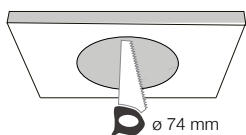
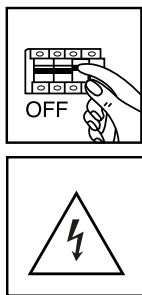

Praticare un foro al soffitto con la misura indicata. Attenzione, rispettare gli spazi d'installazione come da illustrazione.
Drill a hole into the ceiling with the above dimensions. Attention, respect the installation spaces as illustrated.

2

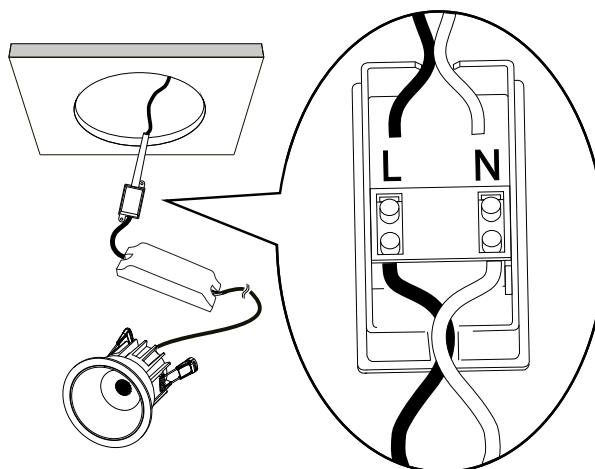

Connettere la morsetteria ai propri cavi come indicato.
Connect the terminal box to your own electric wires as indicated.

3

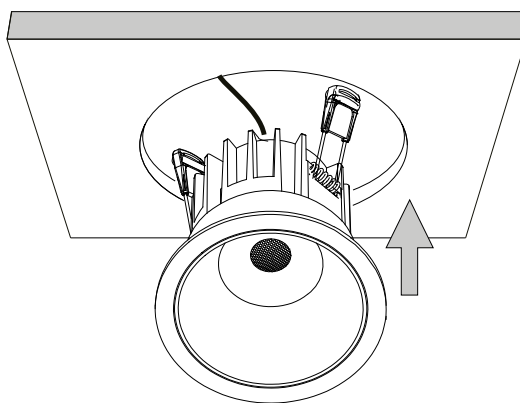

Inserire il faretto nel foro sollevando le molle laterali.
Insert the spotlight into the hole by lifting the side springs.

4

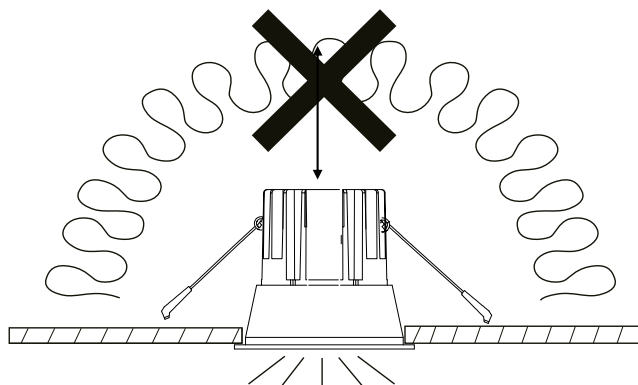

Attenzione! Apparecchio non idoneo ad essere ricoperto di materiale termicamente isolante.

Warning! Luminaire not suitable for covering with thermally insulating material.

