

**Recessed - Empotrable**

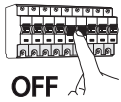

**Cut out**



2

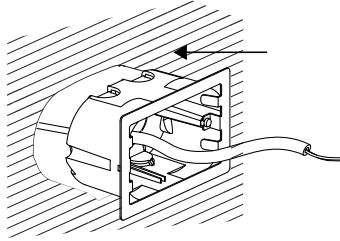

\* See recessed box in [www.faro.es](http://www.faro.es)

3

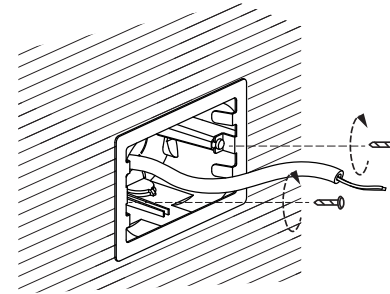

4

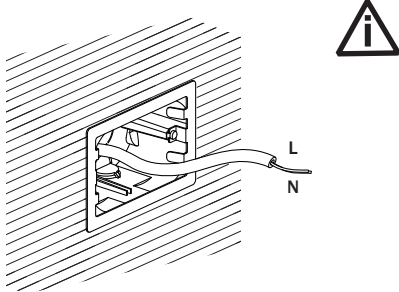

\* Wiring connection box NO INCL. See recessed box in [www.faro.es](http://www.faro.es)

5

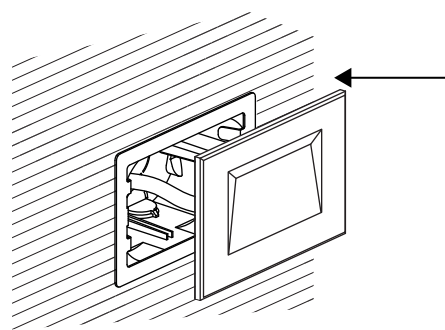

6

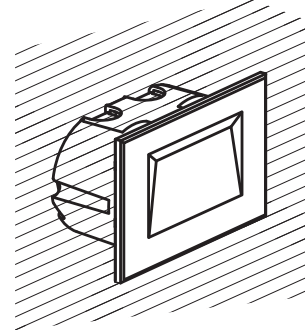

**Surface - Aplique**

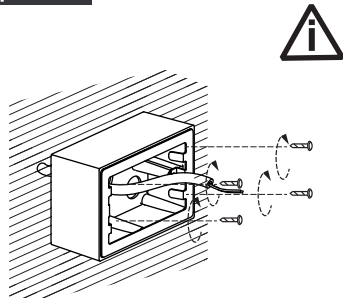

\* See surface box in [www.faro.es](http://www.faro.es)

2

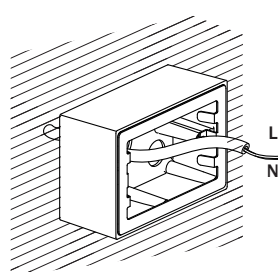

\* Wiring connection box NO INCL. See recessed box in [www.faro.es](http://www.faro.es)

3

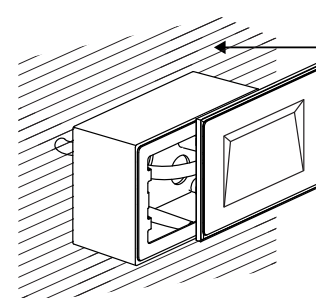

Min IP65 wiring connection box NOT INCLUDED. The installation may need the intervention of a qualified person. The block of connection must comply EN 60998-2-1 or EN 60998-2-2. The block of connection: MAX 10A

Caja de conexión con min IP65 NO INCLUIDA. La instalación puede requerir la intervención de una persona cualificada. El bloque de conexión a incluir debe ser conforme con la EN 60998-2-1 o EN 60998-2-2. Bloque de conexión: MAX 10A

**EXAMPLE - EJEMPLO**

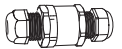

1

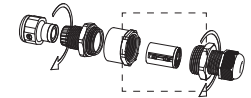

2

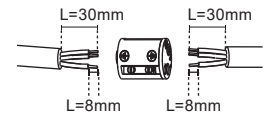

3

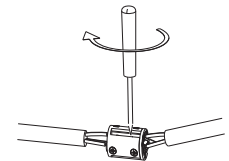

4

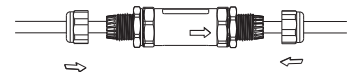

5

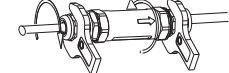

	<b>IP65</b> <b>IK10</b>	Recessed box <b>NO INCL</b>	<b>0,5m</b> H05RN-F 2x1,0mm <sup>2</sup> -Tz

Together we take care of the planet

**DART-1 3000K (70272N-70273N)** **F** This product contains a light source of energy efficiency class F  
Este producto contiene una fuente luminosa de la clase eficiencia energética F

**DART-2 3000K (70277N-70278N)** **D** This product contains a light source of energy efficiency class D  
Este producto contiene una fuente luminosa de la clase eficiencia energética D

**DART-1 2700K (70272-70273)** **G** This product contains a light source of energy efficiency class G  
Este producto contiene una fuente luminosa de la clase eficiencia energética G

**DART-2 2700K (70277-70278)** **F** This product contains a light source of energy efficiency class F  
Este producto contiene una fuente luminosa de la clase eficiencia energética F