



IL4256

IP65 LED OUTDOOR WALL

These instructions are provided for your safety.

Please read them carefully before commencing work and retain them for future reference.

This fitting has an IP rating of IP65 and is suitable for outdoor use when connected as instructed.







SAFETY INFORMATION

- * We recommend any electrical wiring in an outdoor environment is carried out by a qualified electrician. All wiring must comply with the current edition of the IEE wiring regulations and any relevant Building Regulations.
- * If you are in any doubt consult a person competent to give advice on the installation of electrical equipment.
- * This fitting is Class 2 =  therefore no earth is required and should be fitted to a lighting supply protected by a 5 amp fuse or equivalent circuit breaker that is protected by a 30mA RCD.
- * This fitting is rated IP65 and is suitable for outdoor use when fitted in accordance with these instructions and IEE wiring regulations.
- * Before installation and servicing disconnect the electricity supply at the fuse board.
- * To avoid damage to concealed wiring during installation, establish the direction of the supply cable before drilling fixing holes.
- * **IMPORTANT: This LED fitting is NOT dimmable.**
- * The light source of this luminaire is not replaceable; when the light source reaches the end of its end of life the whole luminaire shall be replaced.

SUITABLE FOR WALL MOUNT ONLY, OBSERVE ORIENTATION ARROW INSIDE.



INSTALLATION

Note: This fitting has a 3 year guarantee against corrosion. This fitting should only be installed in normal non aggressive atmospheric locations to prevent corrosion. Aggressive environments to be avoided include locations by the sea, polluted atmospheres or near heating flue outlets.

1. Ensure the house electricity supply is off at the fuse board. 
2. If removing existing fitting, carefully note the position of each set of cables. If there are loop in cables that are not connected to the light these must be terminated in a separate terminal block not connected to the fitting.
3. Remove the backplate from main body of fitting by undoing the retaining screws, retain the screws and any washers / 'O' ring for later. 
4. Using backplate as a template, mark and drill fixing holes. Ensure holes are drilled into a solid wall or other suitable mounting. 
5. Pass cable from the wall through the rubber grommet enclosed terminal block ensuring rubber grommet makes a good watertight seal around cable. 
6. Attach the back plate onto the wall using suitable fixings whilst making sure the 'O rings' provided are used to prevent moisture ingress, take care not to overtighten screws or damage the 'O rings'. 
7. Use a screwdriver to lever open the connector block housing and feed supply cable through the rubber sleeve. Whilst supporting the weight of the fitting, make electrical connections as follows: 

Connect supply live (normally brown or red) to fitting live (marked "L") on the terminal block.
Connect supply neutral (normally blue or black) to fitting neutral (marked "N") on the terminal block.

Please note: No earth should be connected to any part of this fitting. If any earth wires are present please terminate these in a separate terminal block (not supplied) to ensure that continuity is maintained for the earth circuit.

Ensure electrical connections are tight and no loose strands of wire are left out of the terminal block. Ensure terminals and rubber sleeves are correctly seated to prevent water ingress and that any basic insulation is covered with several layers of insulation tape to ensure double insulation is maintained.
8. Attach the main body of the fitting over the back plate and make sure rubber seals are correctly situated before securing main body into position.  **Take care not to damage cable and ensure care is taken not to over tighten screws or damage 'O ring'.**
9. Clean the fitting from dust and finger marks. 
10. Switch on the electricity supply at the fuse board. 

GENERAL INFORMATION

This fitting is designed for external use, it must be fitted to a DRY FINISH as any dampness in concrete, wood stain, paint and etc can damage finish. **Do not use polish or abrasive cleaner - just a soft slightly damp cloth**

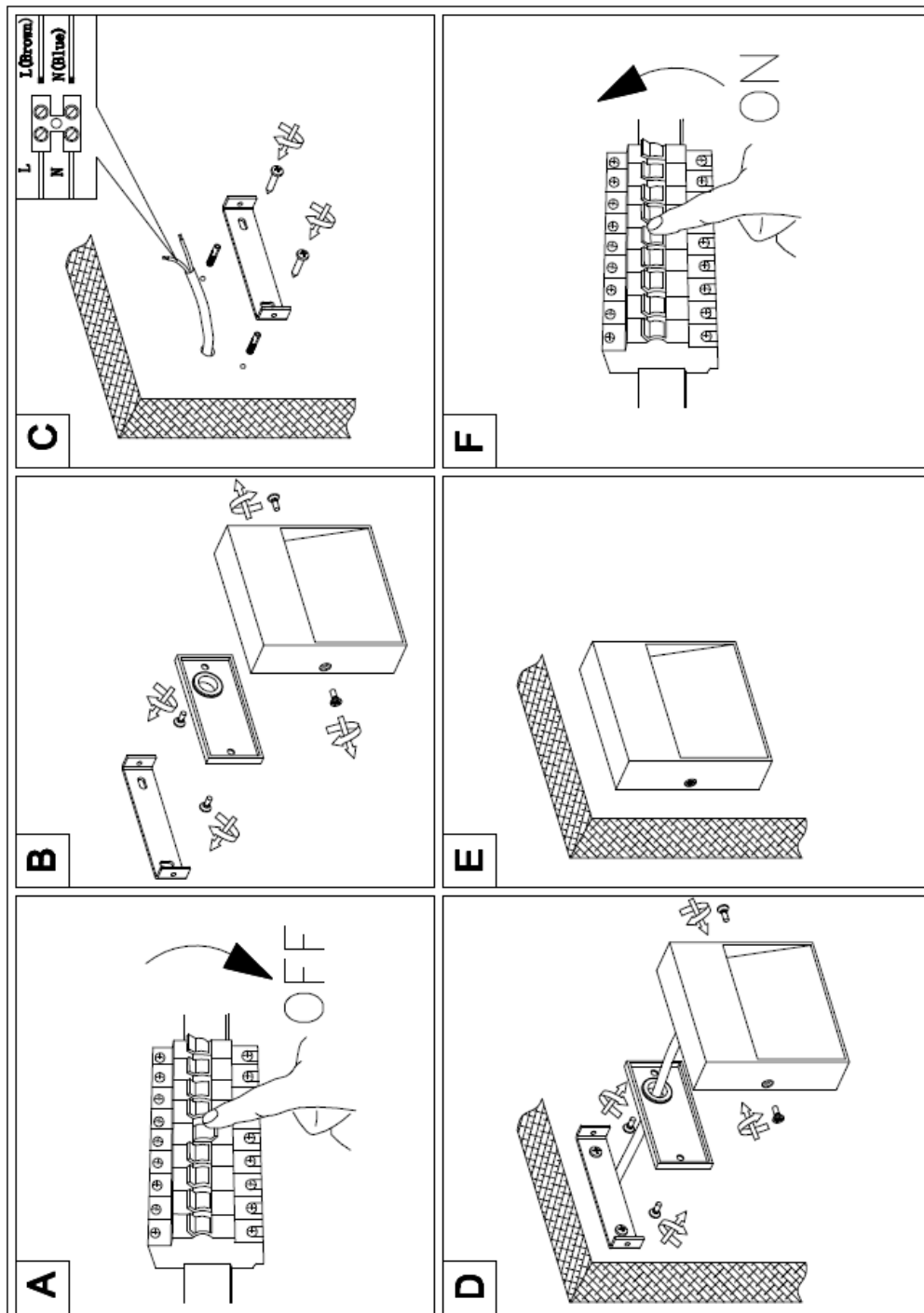

To register your product for an extended five-year warranty, please complete the simple form at

www.darlighting.co.uk/warranty

You'll need to fill in the details of the product, the retailer you purchased it from, and also the installer and the installation. Please also upload a clear copy of the original purchase invoice or receipt to complete this registration.

UK: där Lighting Ltd, Wildmere Road, Banbury, Oxon, OX16 3JZ

Ireland & EU: Dar Lighting Ireland Limited, Suite 108, Q House, 76 Furze Road, Sandyford Industrial Estate, Dublin 18