

INSTRUCTION SHEET

Brilliant

BARTY

G97158...

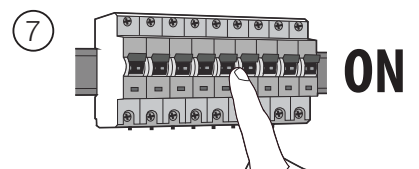
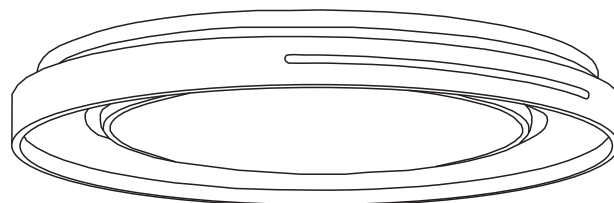
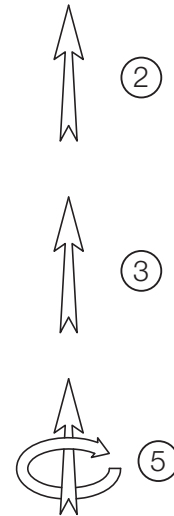
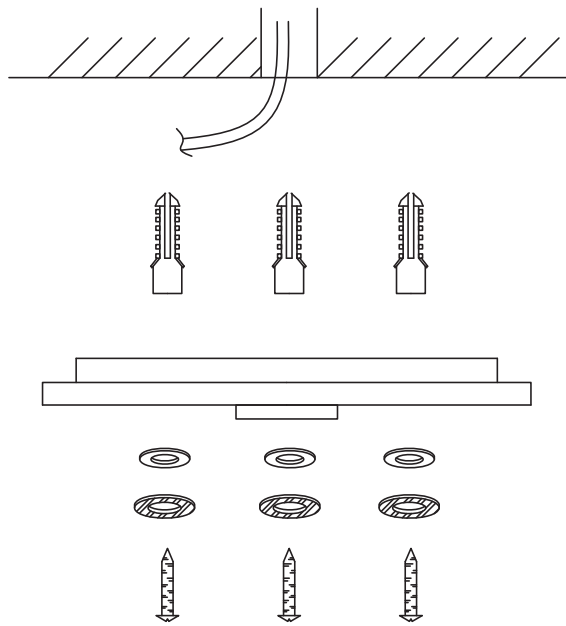
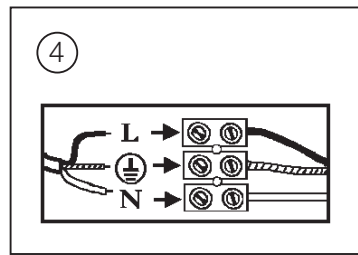
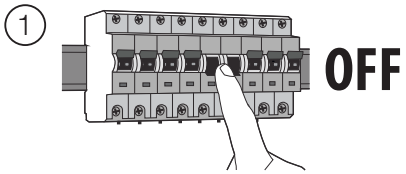

BARTY

G97158...

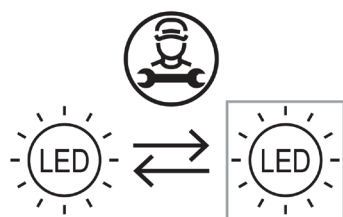
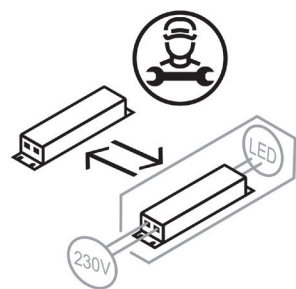
DE: Dieses Produkt enthält eine Lichtquelle der Energieeffizienzklasse F.**EN:** This product contains a light source of energy efficiency class F. .**FR:** Ce produit contient une source lumineuse de classe d'efficacité énergétique F.**ES:** Este producto contiene una fuente luminosa de la clase de eficiencia energética F.**IT:** Questo prodotto contiene una sorgente luminosa di classe di efficienza energetica F.**PL:** Niniejszy produkt zawiera źródło światła klasy efektywności energetycznej F.**PT:** Este produto contém uma fonte de luz de eficiência energética de classe F.**NL:** Dit product bevat een lichtbron van energie-efficiëntieklasse F.**DE:** Die Lichtquelle ist von einer qualifizierten Person austauschbar.**EN:** The light source should be replaced by a qualified person.**FR:** La source lumineuse peut être remplacée par une personne qualifiée.**ES:** Fuente luminosa debe ser sustituida por personal autorizado.**IT:** La sorgente luminosa deve essere sostituita da una persona qualificata.**PL:** Źródło światła powinno być wymieniane przez wykwalifikowaną osobę.**PT:** A fonte de luz pode ser substituída por uma pessoa qualificada.**NL:** De lichtbron kan vervangen worden door een gekwalificeerde persoon.**DE:** Das separate Betriebsgerät ist von einer qualifizierten Person austauschbar.**EN:** The separate control gear should be replaced by a qualified person.**FR:** L'appareil de commande séparé peut être remplacé par une personne qualifiée.**ES:** El aparato separado debe ser sustituido por personal autorizado.**IT:** Il dispositivo di comando separato deve essere sostituito da una persona qualificata.**PL:** Oddzielny zasilacz powinien być wymieniany przez wykwalifikowaną osobę.**PT:** O dispositivo separado pode ser substituído por uma pessoa qualificada.**NL:** De aparte bedieningsinrichting kan vervangen worden door een gekwalificeerde persoon.

Vorsicht, Gefahr des elektrischen Schlags! Caution, risk of electric shock! Danger, risque de chocs électriques! **احترس من حدوث صدمة كهربائية!**
 Attenzione: pericolo di scossa elettrica! Atención, peligro de descarga eléctrica! Voorzichtig, risico op een elektrische schok! Forsigtig - Fare for elektrisk støt! Pozor, nebezpečí zásahu elektrickým proudem! Внимание, опасность от электрического удара! Προσοχή, κίνδυνος ηλεκτροπληξίας! Dikkat, elektrik çarpması riski! Huomio, sähköiskun vaara! Pozor, nebezpečnost zásahu elektrickým proudem! Oprez, opasnost od električnog udara! Uwaga, niebezpieczeństwo porażenia prądem! Pozor, nevarnost električnega udara! Atentje, pericol de electrocutare! Warning! Risk for elektriska stöt! Cuidado, risco de choque elétrico. Vigyázat, áramütés veszélye! Uzmanību: elektriskās strāvas trieciena risks! Kujdes, rrezik nga goditja elektrike! Atsargiai, gali įvykti elektros smūgis! Oprez, opasnost od strujnog udara! Ettevaatus, elektrilöögi oht! Осторожно! Опасность поражения электрическим током! Внимание, опасность од струен удар! OPREZ, OPASNOST OD ELEKTRIČNOG UDARA! Обережно, небезпека ураження електричним струмом! Fare for elektrisk stot!

INSTRUCTION SHEET

Brilliant

BARTY

G97158...

(D)





AN/AUS ---  --- Nach 30 Sekunden ausschalten

3000 - 6500K ---  ---

Lumen + ---  ---

Lichtfarbe ---  K- K+ --- Lichtfarbe +

Lumen - ---  --- Nachtlicht

Lumen ---  20% 50% 100%

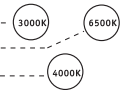
Lichtfarbe ---  3000K 6500K 4000K ---

(GB)





ON/OFF ---  --- After 30 sec. to turn off

3000 - 6500K ---  ---

Lumen + ---  ---

Color Temperature ---  K- K+ --- Color Temperature +

Lumen - ---  --- Nightlight

Lumen ---  20% 50% 100%

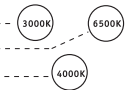
Color Temperature ---  3000K 6500K 4000K ---

(F)



SUR/HORS ---  --- après 30 secondes pour éteindre

3000 - 6500K ---  ---

Lumen + ---  ---

température de couleur ---  K- K+ --- température de couleur +

Lumen - ---  --- veilleuse

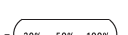
Lumen ---  20% 50% 100%

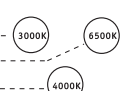
température de couleur ---  3000K 6500K 4000K ---

(I)



SU/FUORI DI ---  --- Dopo 30 secondi per disattivare

3000 - 6500K ---  ---

Lumen + ---  ---

temperatura di colore ---  K- K+ --- temperatura di colore +

Lumen - ---  --- luce notturna

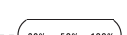
Lumen ---  20% 50% 100%

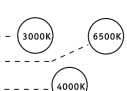
temperatura di colore ---  3000K 6500K 4000K ---

(ES)



encendido/apagado ---  --- Después de 30 segundos para apagar

3000 - 6500K ---  ---

Lumen + ---  ---

temperatura de color ---  K- K+ --- temperatura de color +

Lumen - ---  --- Luz de noche

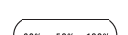
Lumen ---  20% 50% 100%

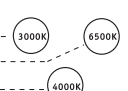
temperatura de color ---  3000K 6500K 4000K ---

(P)



liga / desliga ---  --- Após 30 segundos para desligar

3000 - 6500K ---  ---

lúmen + ---  ---

temperatura de cor ---  K- K+ --- temperatura de cor -

lúmen- ---  --- luz noturna

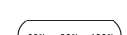
lúmen ---  20% 50% 100%

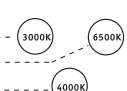
temperatura de cor ---  3000K 6500K 4000K ---

(NL)





AAN/UIT ---  --- Na 30 seconden uitschakelen

3000 - 6500K ---  ---

Lumen + ---  ---

lichte kleur ---  K- K+ --- lichte kleur +

Lumen - ---  --- nachtlamp

Lumen ---  20% 50% 100%

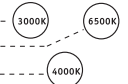
lichte kleur ---  3000K 6500K 4000K ---